

APPLICATIONS

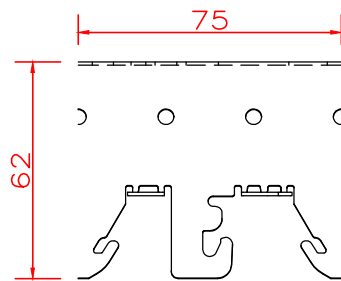

CARRIER 300AC-side

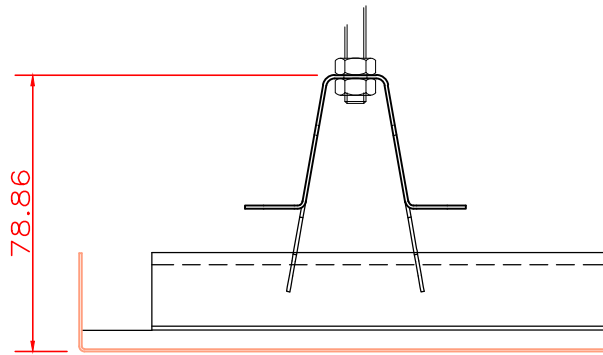
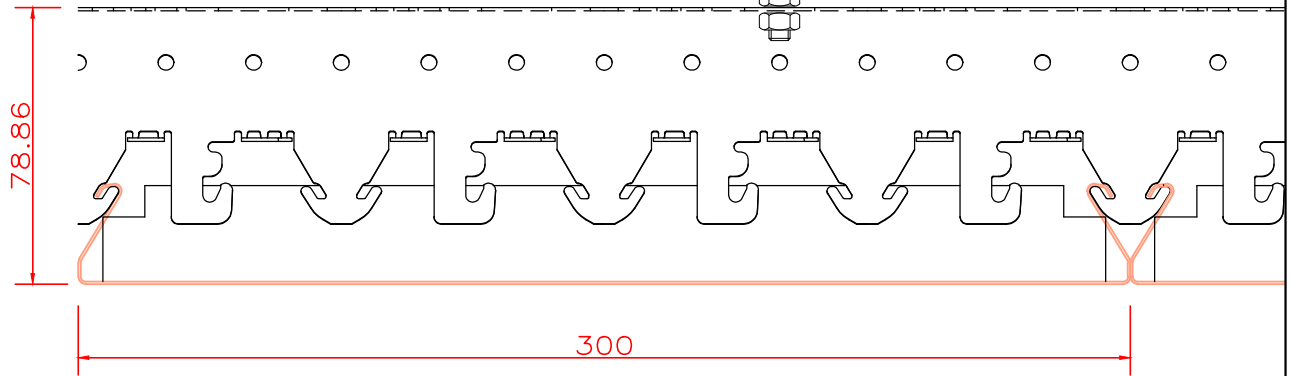
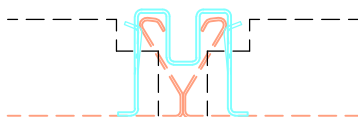

PANEL END CONNECTOR 300L-sec

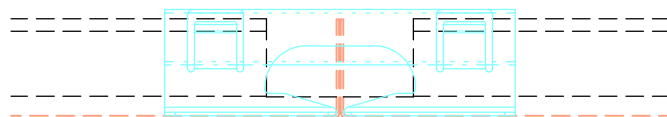

PANEL END CONNECTOR 300L-side

HunterDouglas

HUNTER DOUGLAS EUROPE B.V. Architectural Projects

Window Coverings | Ceilings | Sun Control | Façades

Drwg.No.

C-i-WP-300L-GE-2D-01

Date: 01-04-2014 Scale: 1:2

Size: A4 Rev: 1.0

Subject: Interior 300L carrier System General 2D-Lay



34.1840 300L GENERAL
AL PANEL-sec

300



300C PANEL-sec



34.1840 300L GENERAL
AL PANEL-side

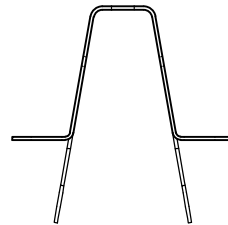

34.4220 AL CARRIER
300AC-sec

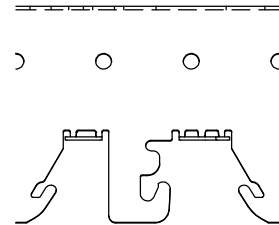

34.4220 AL CARRIER
300AC-side

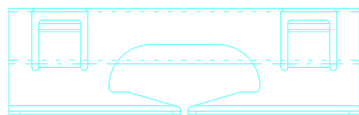

34.4233 PANEL END
CONNECTOR 300L-side



34.4233 PANEL END
CONNECTOR 300L-sec

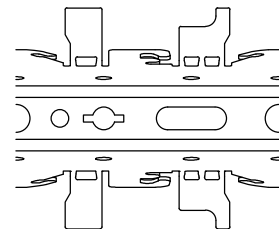

34.4220 AL CARRIER
300AC-top

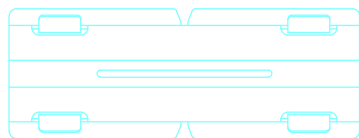

34.4233 PANEL END
CONNECTOR 300L-top

HunterDouglas

HUNTER DOUGLAS EUROPE B.V. Architectural Projects

Window Coverings | Ceilings | Sun Control | Façades

Drwg.No.

C-i-WP-300L-GE-2D-02

Date: 01-04-2014

Size: A4

Scale: 1:2

Rev: 1.0

Subject: Interior 300L carrier System General 2D-Elem.



33.2428 EDGE PROFILE
0.8 AL-L 45x18.5-sec



33.5402 HOLD-DOWN CLIP
FOR L EDGE PROFILE-side



33.4789 SUSPENSION
ELEMENT-side



33.4789 SUSPENSION
ELEMENT-front

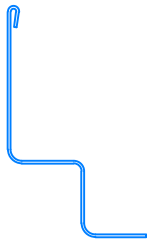

33.2424 EDGE PROFILE
0.8 AL-W 45x21x21x18.5-sec

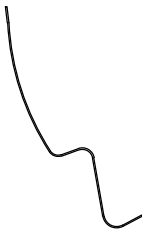

33.5403 HOLD-DOWN CLIP
FOR W EDGE PROFILE-side



34.4315 LOWER NONIUS
HANGER-front

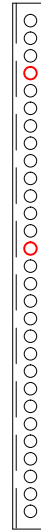

34.4315 LOWER NONIUS
HANGER-side



34.4180 LUXALON EDGE
COVER FIX PIECE - top



34.4180 LUXALON EDGE
COVER FIX PIECE - side

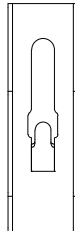

34.4180 LUXALON EDGE
COVER FIX PIECE - front



33.4173 CARRIER SPLICE-front



33.4173 CARRIER SPLICE-side

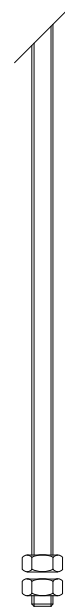

ACC THREADED M6-side

HunterDouglas

HUNTER DOUGLAS EUROPE B.V.

Architectural Projects

Window Coverings

Ceilings

Sun Control

Façades

Drwg.No.

C-i-WP-300L-GE-2D-03

Date:

01-04-2014

Scale:

1:2

Size:

A4

Rev:

1.0

Subject: Interior 300L carrier System General 2D-Acc