

* -

HunterDouglas 
Architectural

Drwg.No. C-i-SMe-PI-Beta -Hook on Safetyloop -Spec -2D_Application A	Date: 19.08.2019	Scale: 1:5
	Size: A3	Rev: -
Subject: Ceiling Interior Stretch Metal Planks Beta Hook on Safetyloop Special		

**Stretch Metal Plank Beta Hook-on
Special 50 Al / Fe**

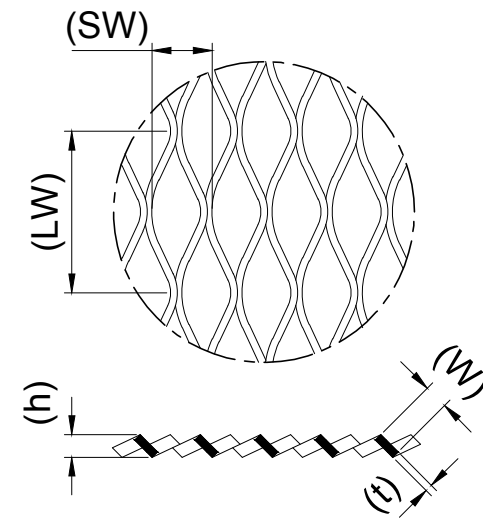
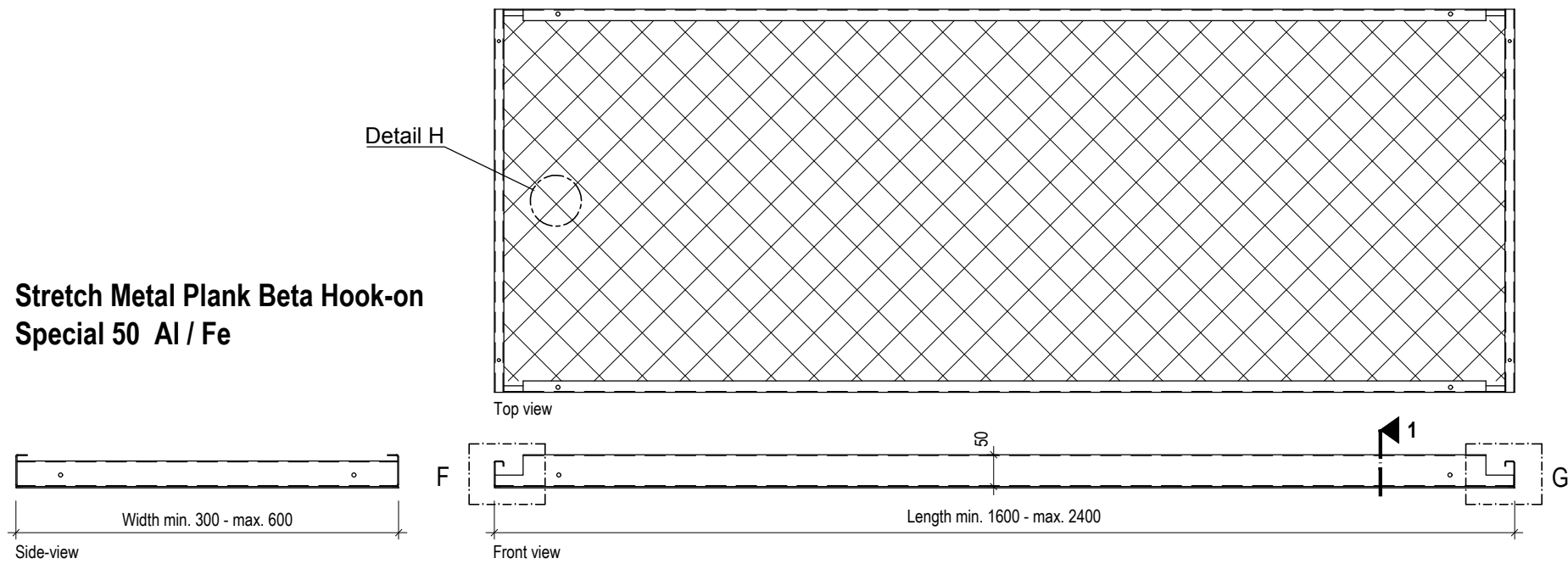

Detail H scale :-
Orientation stretch metal
For dimensions see brochure

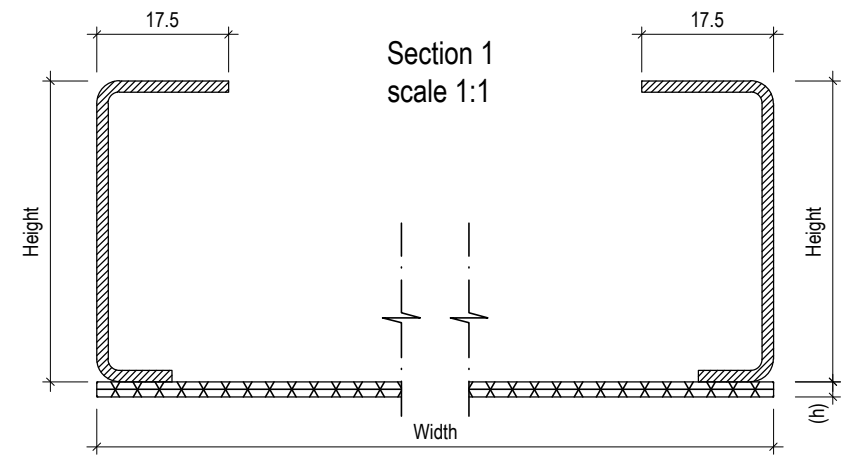

Width from	Width to	Length from	Length to	Height
300	600	800	1200	30
300	600	1200	1600	40
300	600	1600	2400	50

**Stretch Metal Plank Beta Hook-on
Special 40 Al / Fe**

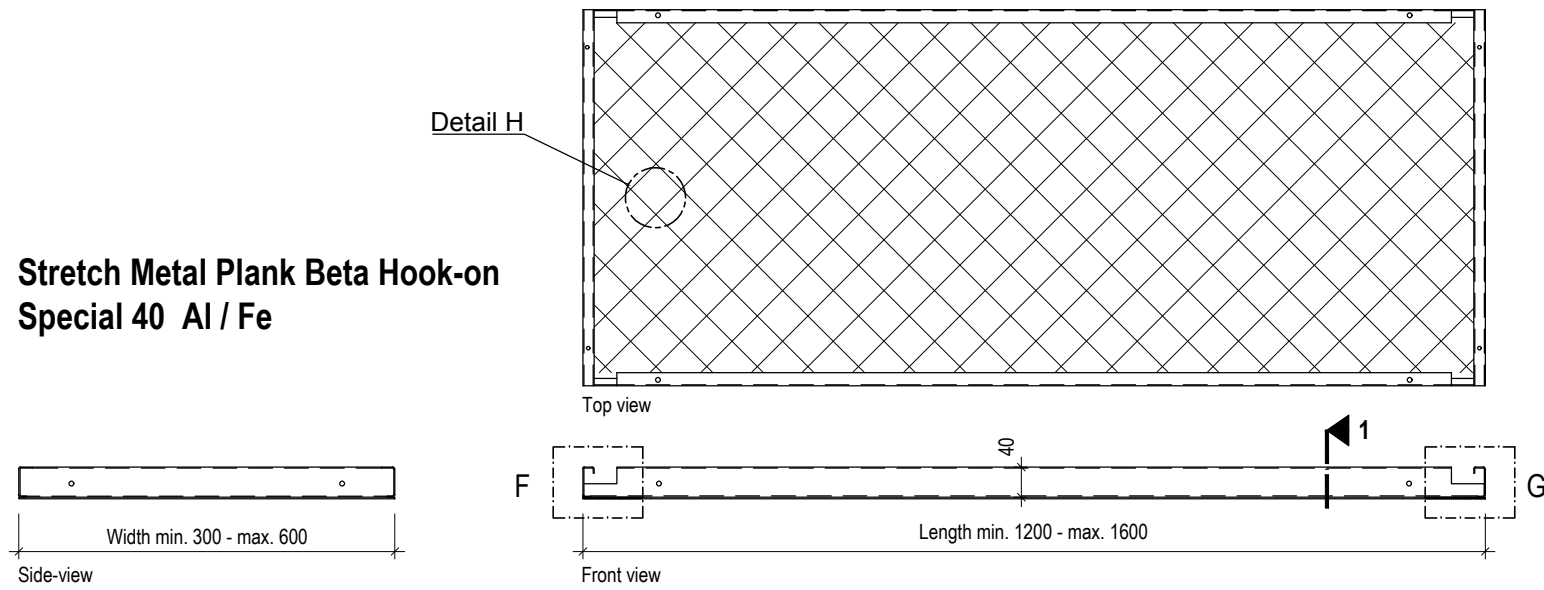

**Stretch Metal Plank Beta Hook-on
Special 30 Al / Fe**

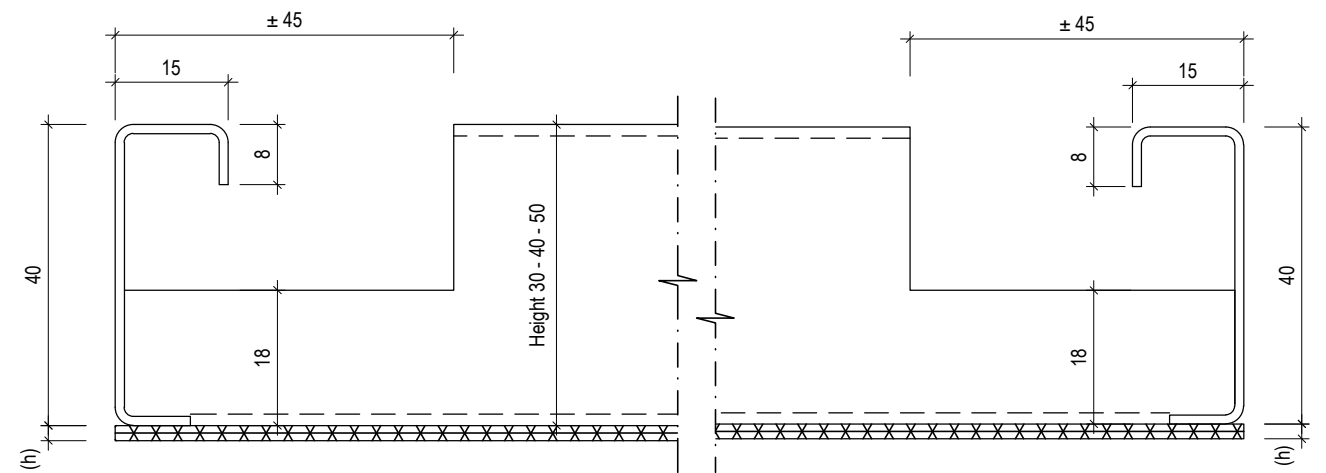
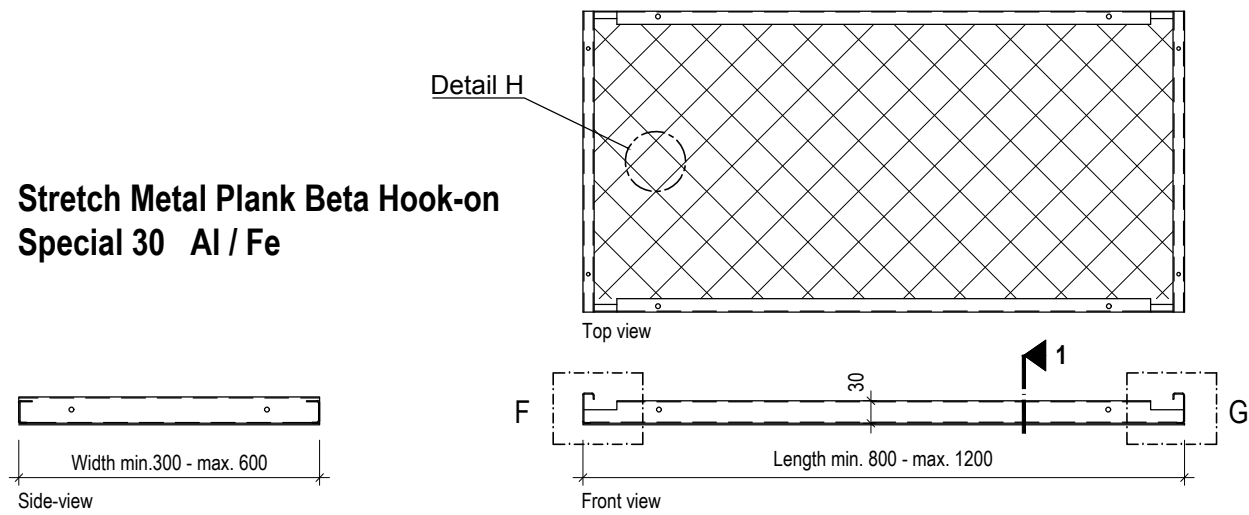

Detail F scale 1:1

Detail G scale 1:1

Z-PROFILE 40 Fe

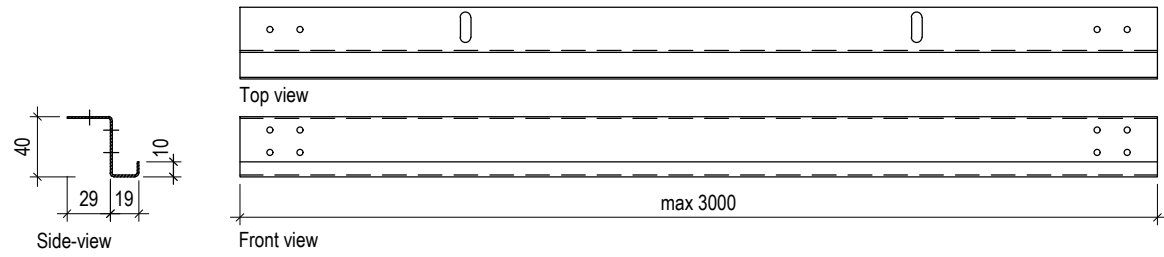

Z-PROFILE SPLICE 40

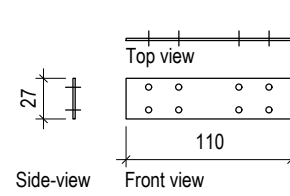

PRIMARY PROFILE Fe

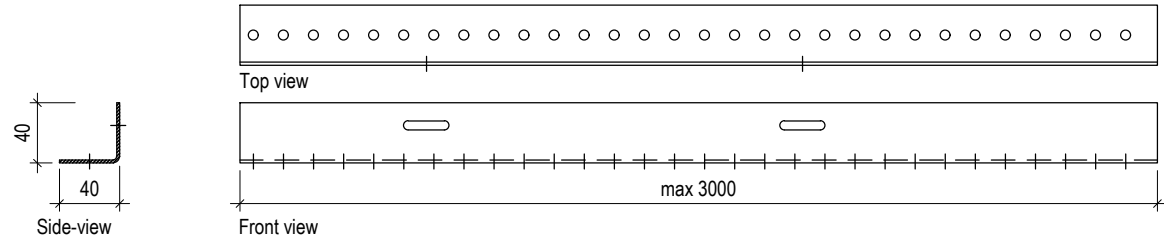

SPACER 3 mm

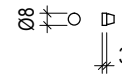

SAFETY LOOP PROFILE Fe

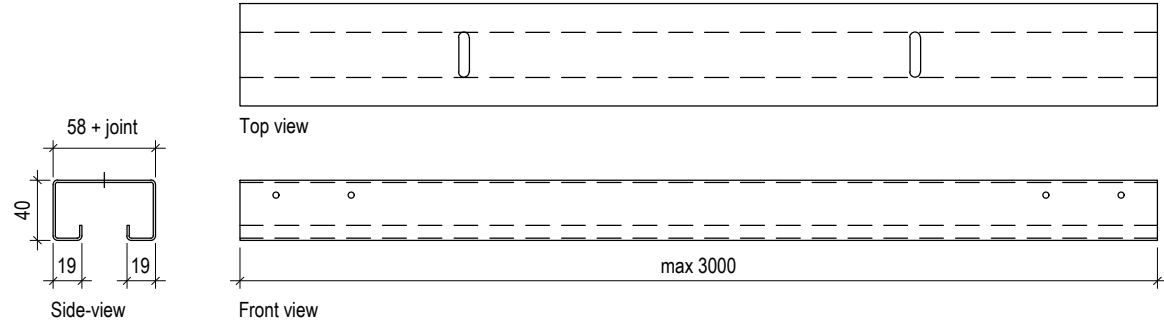

SAFETY LOOP LOCKING PLATE 68

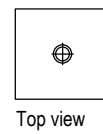

Top view

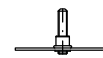

Front view

SAFETY LOOP SPLICE 68

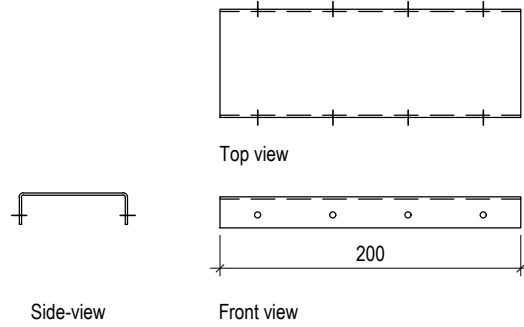

UPPER NONIUS HANGER
Length: 150, 300, 500, 1000, 1500, 2000mm

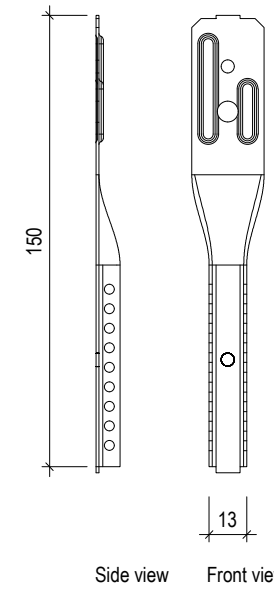

LOWER NONIUS HANGER

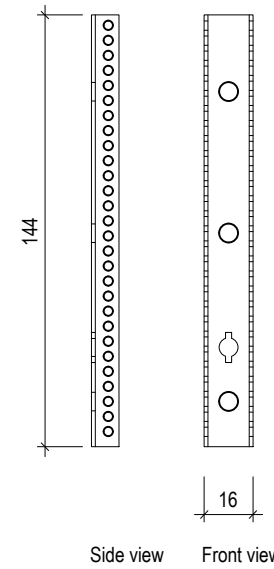

EDGE-PROFILE Al / Fe

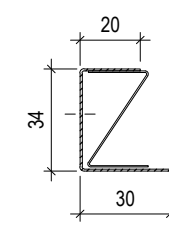

EDGE-PROFILE U 30
L= max.3000 mm

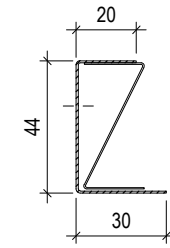

EDGE-PROFILE U 40
L= max.3000 mm

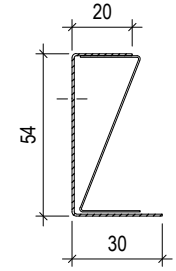

EDGE-PROFILE U 50
L= max.3000 mm

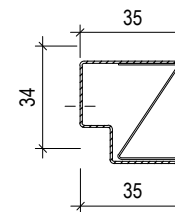

EDGE-PROFILE UW 30
L= max.3000 mm

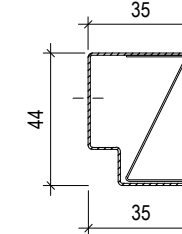

EDGE-PROFILE UW 40
L= max.3000 mm

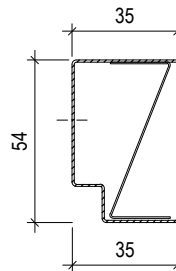

EDGE-PROFILE UW 50
L= max.3000 mm

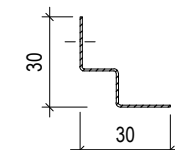

EDGE-PROFILE W 30
L= max.3000 mm

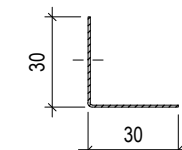

EDGE-PROFILE L 30
L= max.3000 mm



LOCKING-PROFILE 30
L= max.1160 mm



LOCKING-PROFILE 40
L= max.1160 mm



LOCKING-PROFILE 50
L= max.1160 mm