

* -

HunterDouglas 
 Architectural

Drwg.No. C-i-SMe-PI-Gamma -Lay-on -2D_Application A	Date: 19.08.2019	Scale: 1:5
	Size: A3	Rev: -
Subject: Ceiling Interior Stretch Metal Planks Gamma Lay-on		

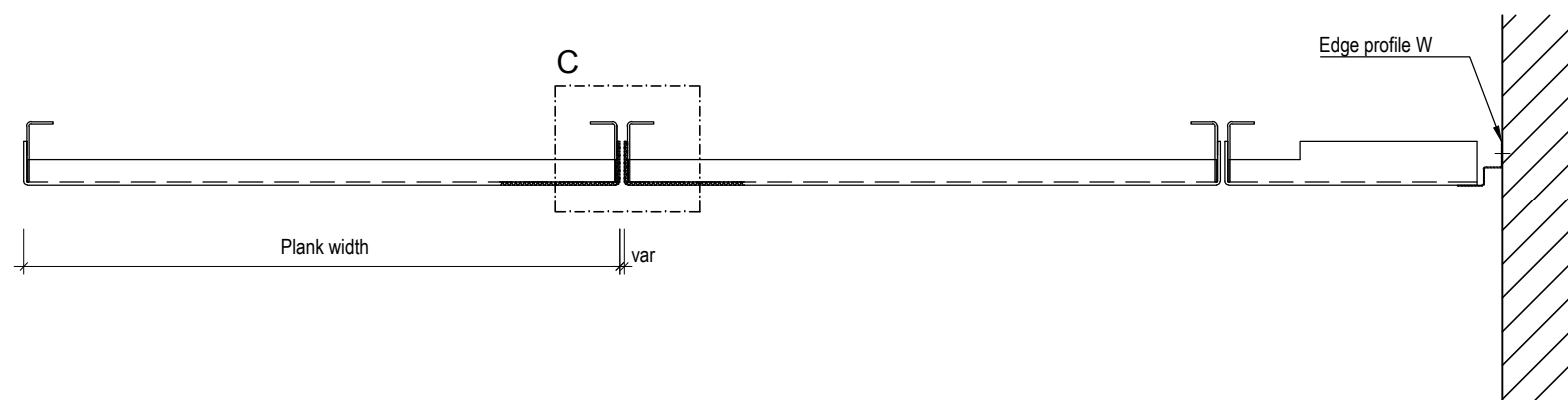
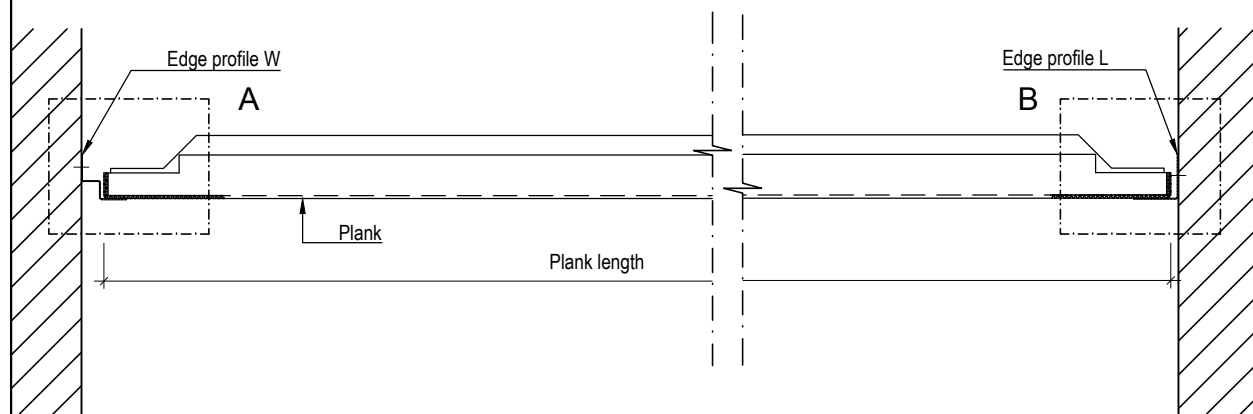
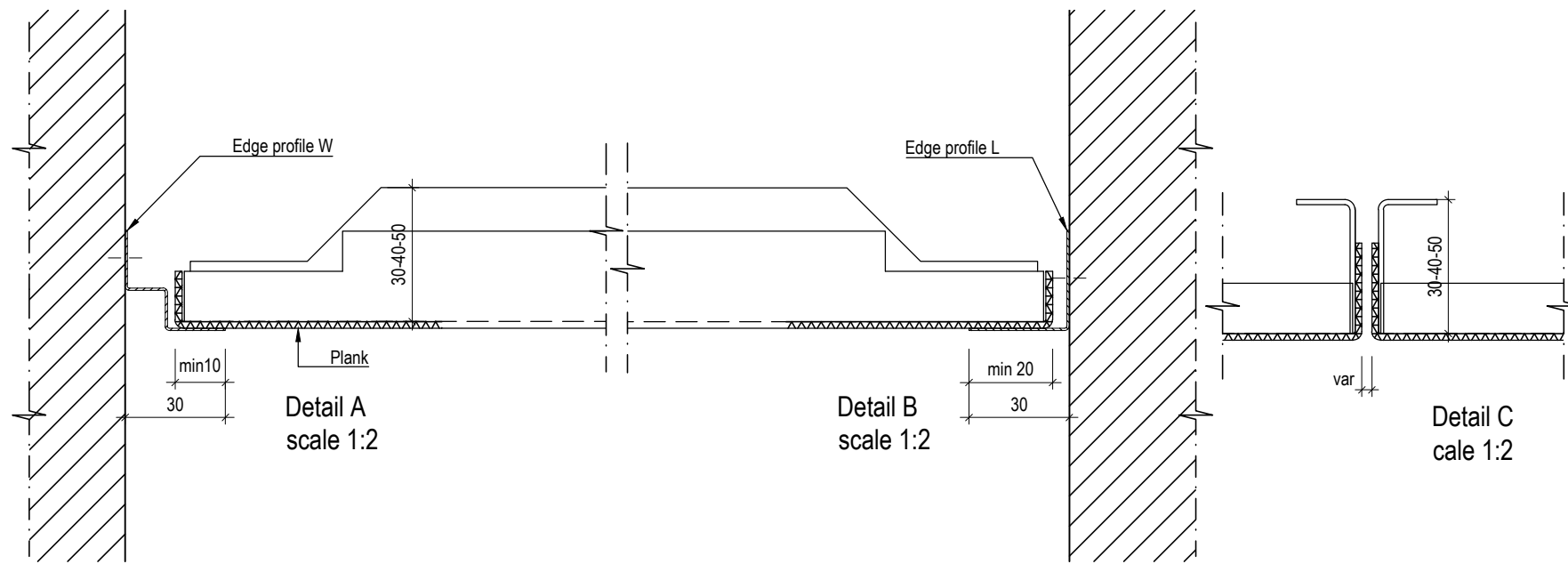
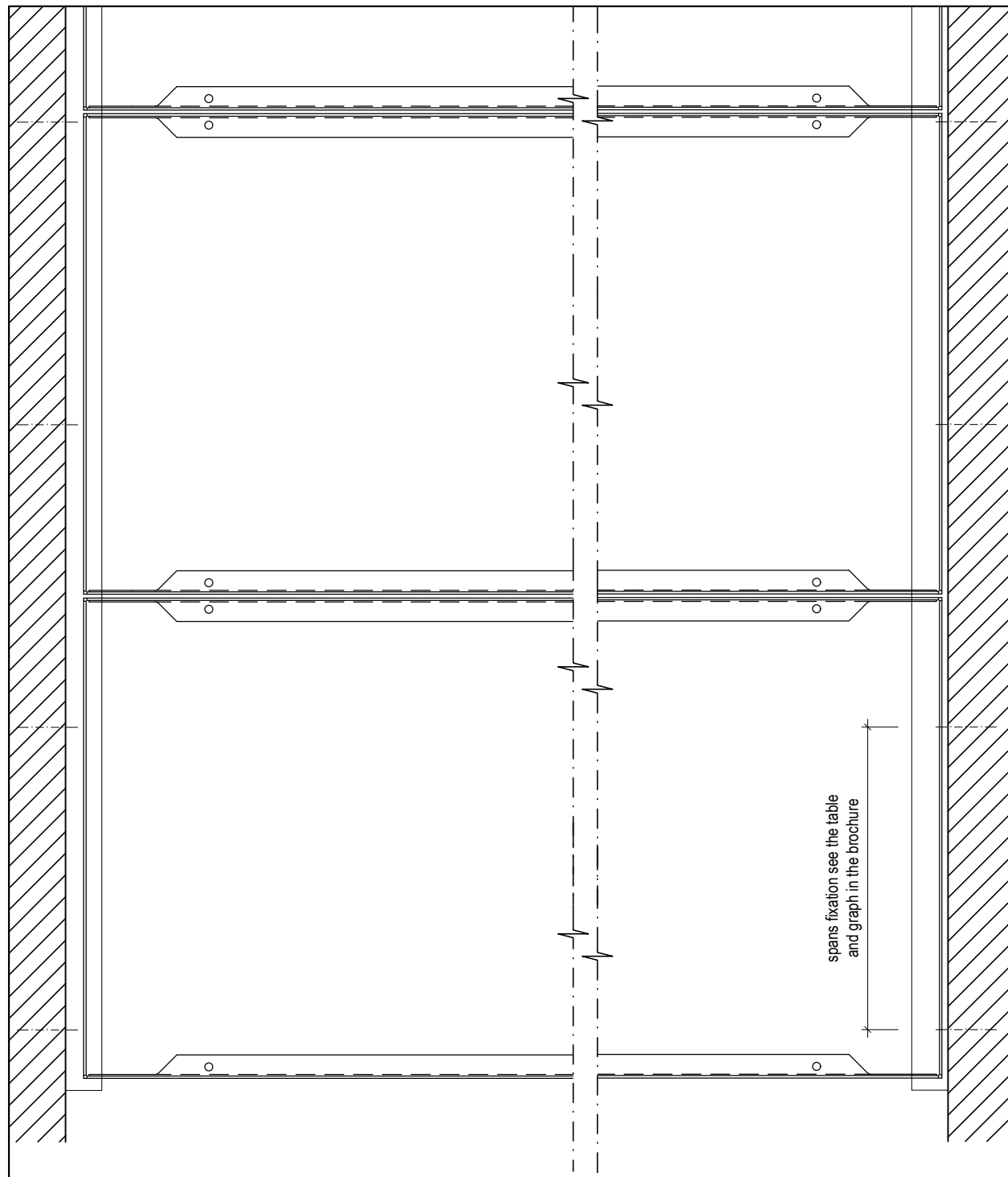

* -

HunterDouglas 
Architectural

Drwg.No. C-i-SMe-PI-Gamma -Lay-on -2D_Application B	Date: 19.08.2019	Scale: 1:5
	Size: A3	Rev: -
Subject: Ceiling Interior Stretch Metal Planks Gamma Lay-on		

**Stretch Metal Plank Gamma
Lay-on 50 Al / Fe**

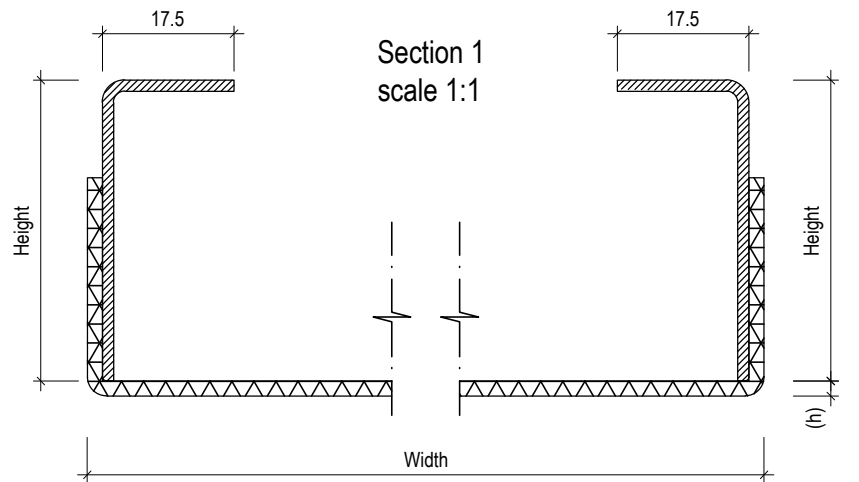
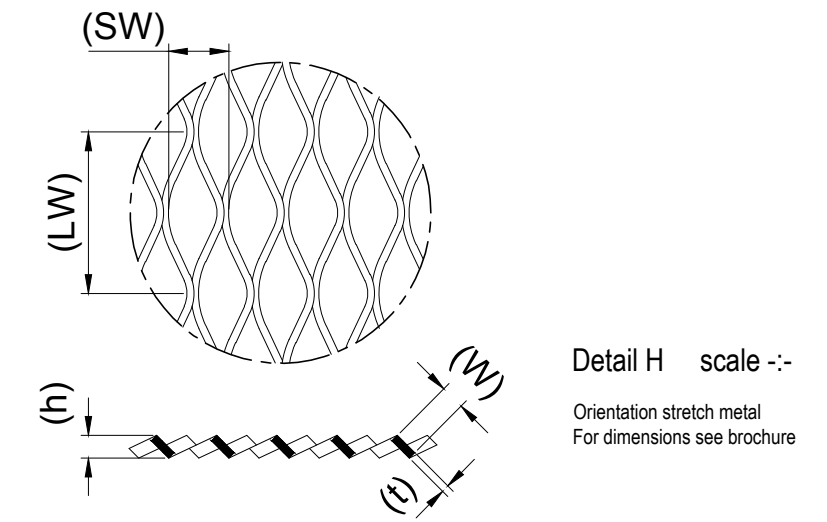
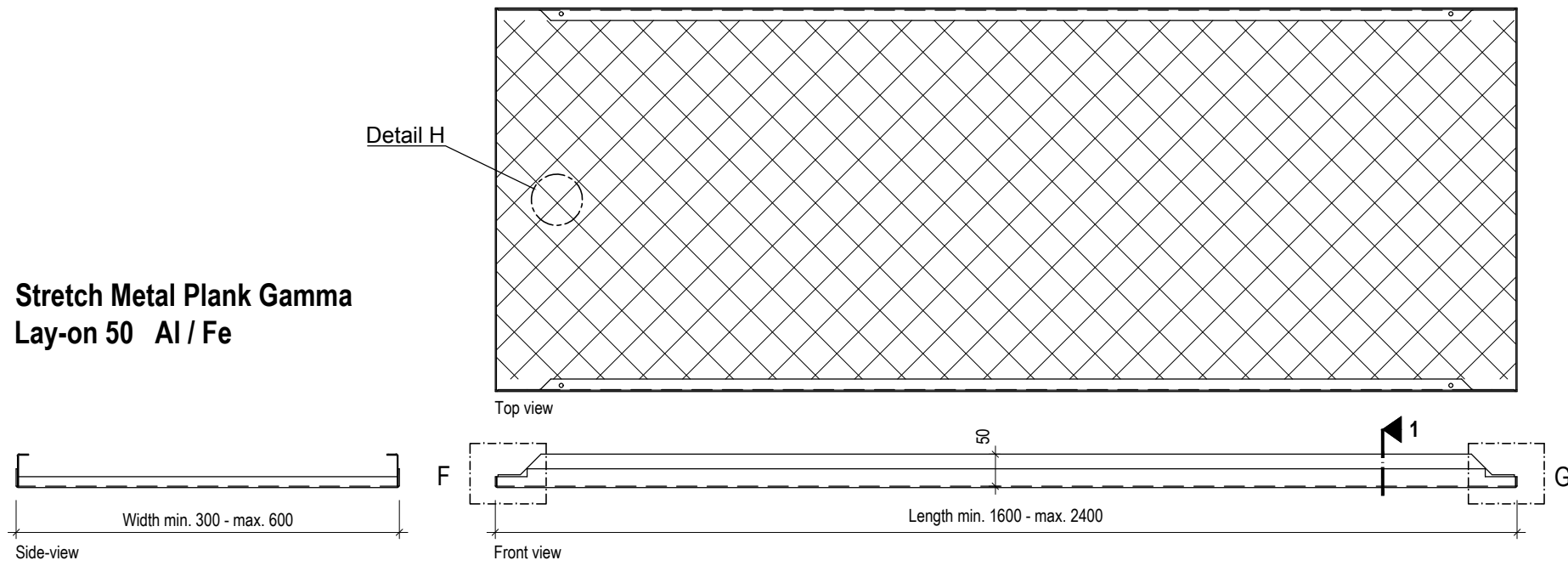

Width from	to	Length from	to	Height
300	600	800	1200	30
300	600	1200	1600	40
300	600	1600	2400	50

**Stretch Metal Plank Gamma
Lay-on 40 Al / Fe**

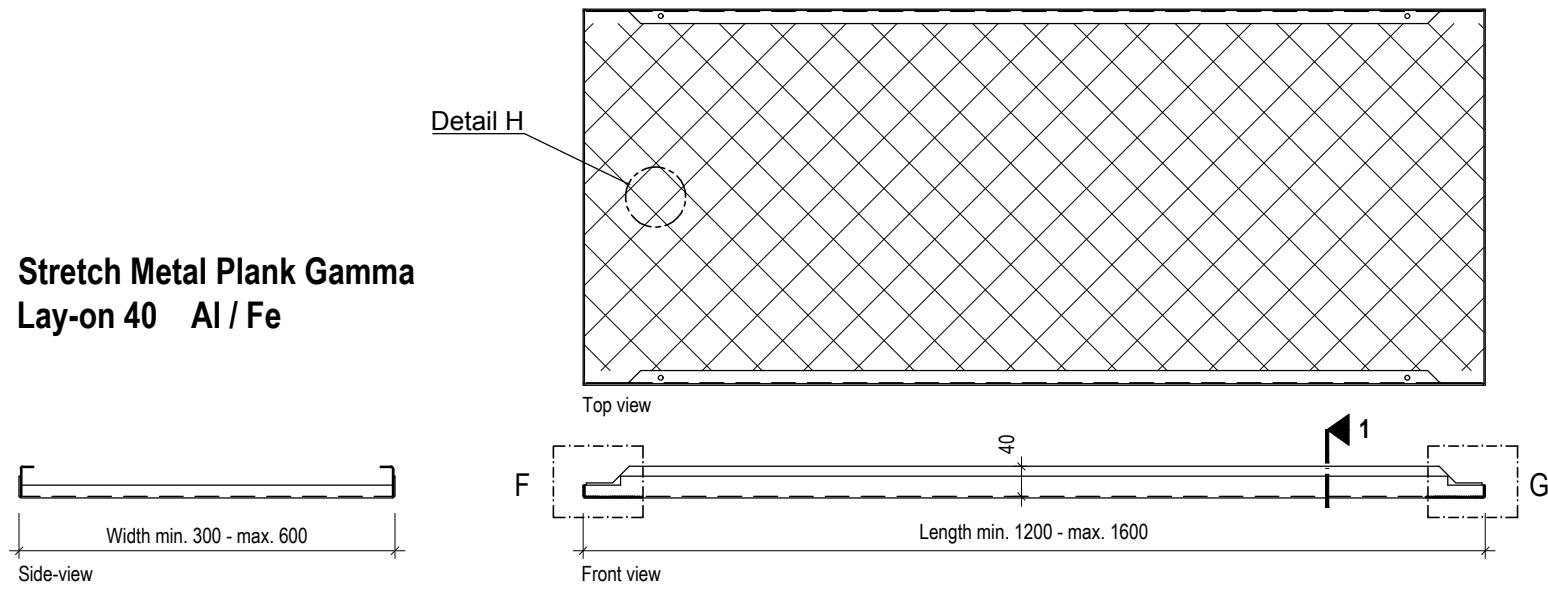

**Stretch Metal Plank Gamma
Lay-on 30 Al / Fe**

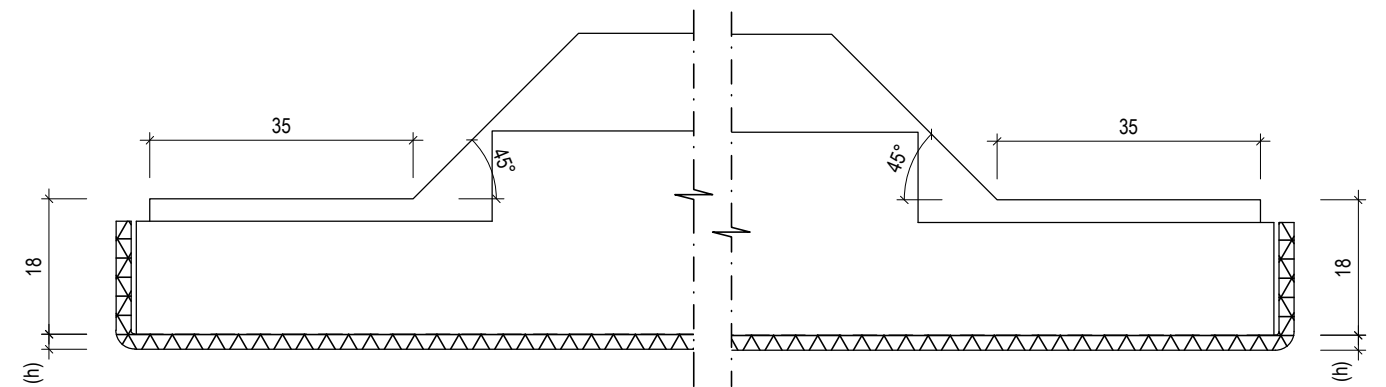
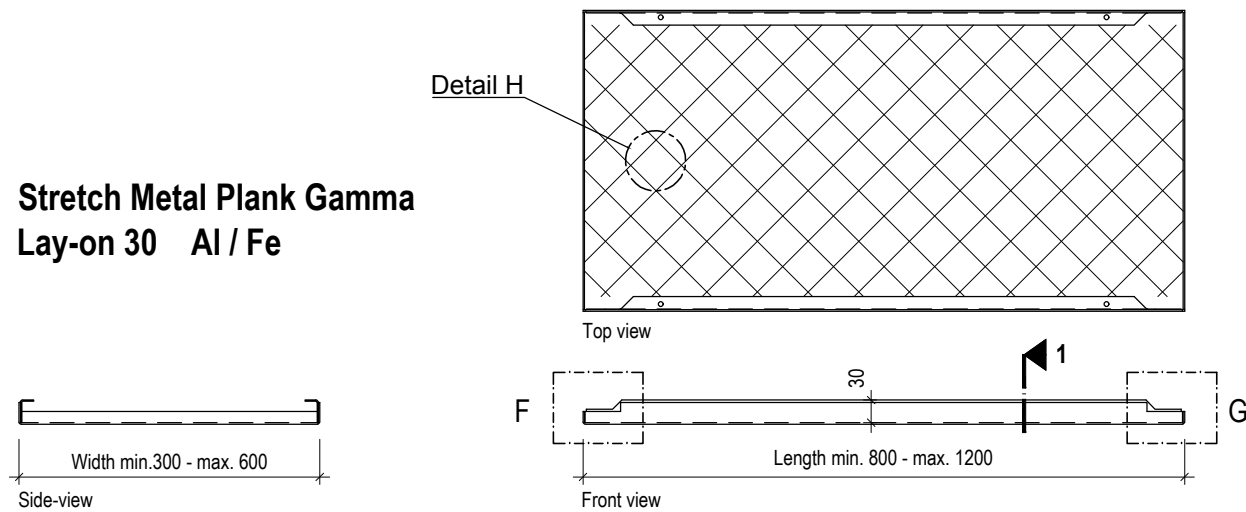

**GAMMA BANDRASTER
(Non Hunter Douglas)**

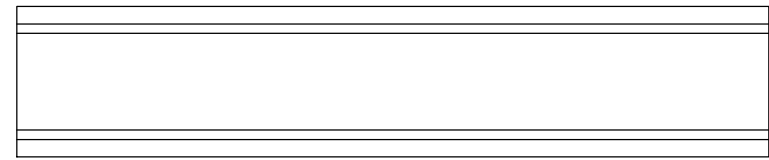

Top view

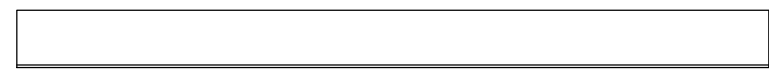

Front view max 4000

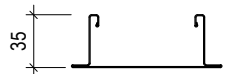

Side-view
50-75-100-125-150

**GAMMA BANDRASTER SPLICE
(Non Hunter Douglas)**

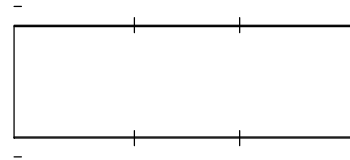

Top view



Front view 230



Side-view
50-75-100-125-150

**UPPER NONIUS HANGER
Length: 150, 300, 500, 1000, 1500, 2000mm**

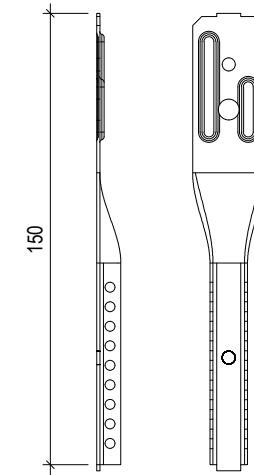

Side view Front view

LOWER NONIUS HANGER

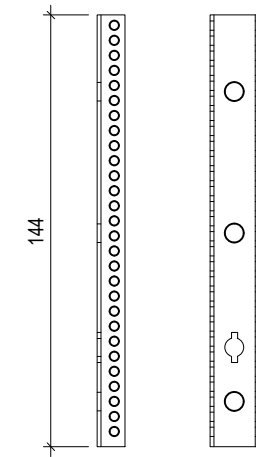

Side view Front view

**GAMMA BRACKET 50 - 75 - 100 - 125 - 150
(Non Hunter Douglas)**

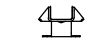

Top view 50

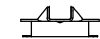

Top view 75

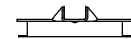

Top view 100

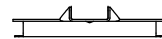

Top view 125

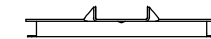

Top view 150

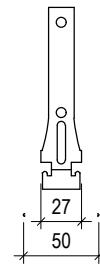

Front view 50

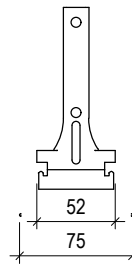

Front view 75

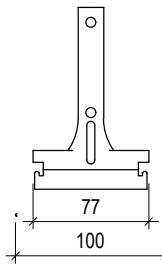

Front view 100

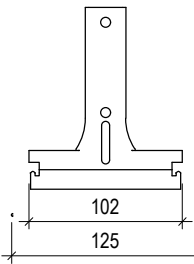

Front view 125

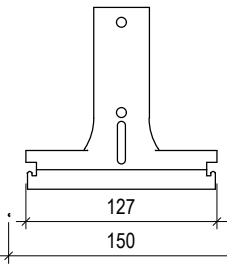

Front view 150

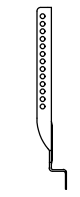

Side-view

EDGE-PROFILE U Al / Fe

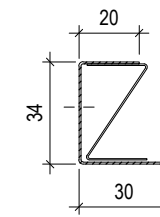

EDGE-PROFILE U 30
L= max.3000 mm

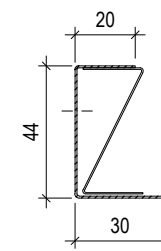

EDGE-PROFILE U 40
L= max.3000 mm

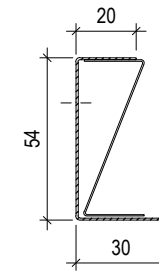

EDGE-PROFILE U 50
L= max.3000 mm

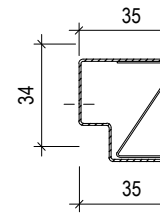

EDGE-PROFILE UW 30
L= max.3000 mm

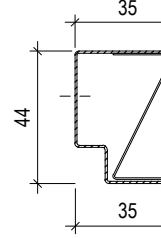

EDGE-PROFILE UW 40
L= max.3000 mm

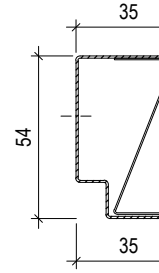

EDGE-PROFILE UW 50
L= max.3000 mm

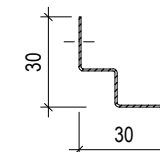

EDGE-PROFILE W 30
L= max.3000 mm

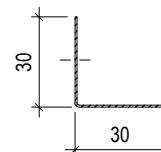

EDGE-PROFILE L 30
L= max.3000 mm



LOCKING-PROFILE 30
L= max.1160 mm



LOCKING-PROFILE 40
L= max.1160 mm



LOCKING-PROFILE 50
L= max.1160 mm